



Features

- Organization: 8,192 words × 8 bits
- High speed
 - 8/10/12/15/20 ns address access time
 - 3/3/3/4/5 ns output enable access time
- Low power consumption
 - Active: 633 mW max (10 ns cycle)
 - Standby: 11 mW max, CMOS I/O
- Very low DC component in active power
- 2.0V data retention
- Equal access and cycle times
- Very fast 3 ns output enable access time
- Easy memory expansion with $\overline{CE1}$, $CE2$, \overline{OE} inputs
- TTL-compatible, three-state I/O
- 28-pin JEDEC standard packages
- 300 mil PDIP and SOJ
- ESD protection ≥ 2000 volts
- Latch-up current ≥ 200 mA

SRAM

Logic block diagram

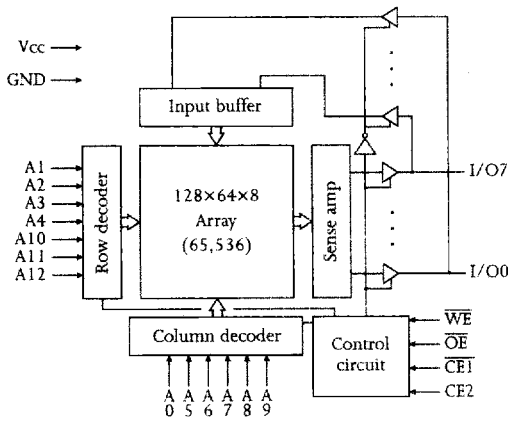

Pin arrangement

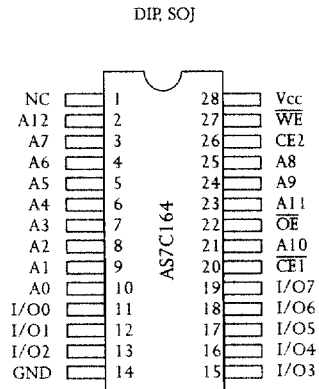

Selection guide

	7C164-8	7C164-10	7C164-12	7C164-15	7C164-20	Unit
Maximum address access time	8	10	12	15	20	ns
Maximum output enable access time	3	3	3	4	5	ns
Maximum operating current	120	115	110	100	90	mA
Maximum CMOS standby current	2.0	2.0	2.0	2.0	2.0	mA



Functional description

The AS7C164 is a high performance CMOS 65,536-bit Static Random Access Memory (SRAM) organized as 8,192 words \times 8 bits. It is designed for memory applications where fast data access, low power, and simple interfacing are desired.

Equal address access and cycle times (t_{AA} , t_{RC} , t_{WC}) of 8/10/12/15/20 ns with output enable access times (t_{OE}) of 3/3/3/4/5 ns are ideal for high performance applications. Active high and low chip enables ($\overline{CE1}$, CE2) permit easy memory expansion with multiple-bank memory systems.

When $\overline{CE1}$ is High or CE2 is Low the device enters standby mode. The standard AS7C164 is guaranteed not to exceed 11.0 mW power consumption in standby mode, and typically requires only 250 μ W; it offers 2.0V data retention with maximum power of 120 μ W.

A write cycle is accomplished by asserting write enable (\overline{WE}) and both chip enables ($\overline{CE1}$, CE2). Data on the input pins I/O0-I/O7 is written on the rising edge of \overline{WE} (write cycle 1) or the active-to-inactive edge of $\overline{CE1}$ or CE2 (write cycle 2). To avoid bus contention, external devices should drive I/O pins only after outputs have been disabled with output enable (\overline{OE}) or write enable (\overline{WE}).

A read cycle is accomplished by asserting output enable (\overline{OE}) and both chip enables ($\overline{CE1}$, CE2), with write enable (\overline{WE}) High. The chip drives I/O pins with the data word referenced by the input address. When either chip enable or output enable is inactive, or write enable is active, output drivers stay in high-impedance mode.

All chip inputs and outputs are TTL-compatible, and operation is from a single 5V supply. The AS7C164 is packaged in all high volume industry standard packages.

Absolute maximum ratings

Parameter	Symbol	Min	Max	Unit
Voltage on any pin relative to GND	V_t	-0.5	+7.0	V
Power dissipation	P_D	—	1.0	W
Storage temperature (plastic)	T_{stg}	-55	+150	$^{\circ}$ C
Temperature under bias	T_{bias}	-10	+85	$^{\circ}$ C
DC output current	I_{out}	—	20	mA

NOTE: Stresses greater than those listed under Absolute Maximum Ratings may cause permanent damage to the device. This is a stress rating only and functional operation of the device at these or any other conditions outside those indicated in the operational sections of this specification is not implied. Exposure to absolute maximum rating conditions for extended periods may affect reliability.

Truth table

$\overline{CE1}$	CE2	\overline{WE}	\overline{OE}	Data	Mode
H	X	X	X	High Z	Standby (I_{SB} , I_{SB1})
X	L	X	X	High Z	Standby (I_{SB} , I_{SB1})
L	H	H	H	High Z	Output disable
L	H	H	L	D_{out}	Read
L	H	L	X	D_{in}	Write

Key: X = Don't Care, L = Low, H = High



Recommended operating conditions

Applicable to all portions of this specification unless otherwise noted.

Parameter	Symbol	Min	Typ	Max	Unit
Supply voltage	V_{CC}	4.5	5.0	5.5	V
	GND	0.0	0.0	0.0	V
Input voltage	V_{IH}	2.2	–	$V_{CC}+1$	V
	V_{IL}	-0.5^*	–	0.8	V
Ambient operating temperature	T_a	0	–	70	

* V_{IL} min = $-3.0V$ for pulse width less than $t_{RC}/2$.

DC operating characteristics

Parameter	Symbol	Test Conditions	-8		-10		-12		-15		-20		Unit
			Min	Max	Min	Max	Min	Max	Min	Max	Min	Max	
Input leakage current	$ I_{IL} $	$V_{CC} = \text{Max},$ $V_{in} = \text{GND to } V_{CC}$	–	1	–	1	–	1	–	1	–	1	μA
Output leakage current	$ I_{LO} $	$\overline{CE1} = V_{IH}$ or $CE2 = V_{IL},$ $V_{CC} = \text{Max},$ $V_{out} = \text{GND to } V_{CC}$	–	1	–	1	–	1	–	1	–	1	μA
Operating power supply current	I_{CC}	$\overline{CE1} = V_{IL}, CE2 = V_{IH},$ $f = f_{max}, I_{out} = 0 \text{ mA}$	–	120	–	115	–	110	–	100	–	90	mA
Standby power supply current	I_{SB}	$\overline{CE1} = V_{IH}$ or $CE2 = V_{IL},$ $f = f_{max}$	–	40	–	35	–	30	–	25	–	25	mA
	I_{SB1}	$\overline{CE1} \geq V_{CC}-0.2V$ or $CE2 \leq 0.2V,$ $V_{in} \leq 0.2V$ or $V_{in} \geq V_{CC}-0.2V, f = 0$	–	2.0	–	2.0	–	2.0	–	2.0	–	2.0	mA
Output voltage	V_{OL}	$I_{OL} = 8 \text{ mA}, V_{CC} = \text{Min}$	–	0.4	–	0.4	–	0.4	–	0.4	–	0.4	V
	V_{OH}	$I_{OH} = -4 \text{ mA}, V_{CC} = \text{Min}$	2.4	–	2.4	–	2.4	–	2.4	–	2.4	–	V

Capacitance

 $f = 1 \text{ MHz}, T_a = \text{room temperature}$

Parameter	Symbol	Signals	Test conditions	Max	Unit
Input capacitance	C_{IN}	A, $\overline{CE1}, CE2, \overline{WE}, \overline{OE}$	$V_{in} = 0V$	5	pF
I/O capacitance	$C_{I/O}$	I/O	$V_{in} = V_{out} = 0V$	7	pF

Key to switching waveforms

Rising input

Falling input

Undefined output/don't care



Read cycle

SRAM

Parameter	Symbol	-8		-10		-12		-15		-20		Unit	Notes
		Min	Max	Min	Max	Min	Max	Min	Max	Min	Max		
Read cycle time	t_{RC}	8	-	10	-	12	-	15	-	20	-	ns	
Address access time	t_{AA}	-	8	-	10	-	12	-	15	-	20	ns	3
Chip enable ($\overline{CE1}$) access time	t_{ACE1}	-	8	-	10	-	12	-	15	-	20	ns	3, 12
Chip enable (CE2) access time	t_{ACE2}	-	8	-	10	-	12	-	15	-	20	ns	3, 12
Output enable (\overline{OE}) access time	t_{OE}	-	3	-	3	-	3	-	4	-	5	ns	
Output hold from address change	t_{OH}	3	-	3	-	3	-	3	-	3	-	ns	5
$\overline{CE1}$ Low to output in low Z	t_{CLZ1}	3	-	3	-	3	-	3	-	3	-	ns	4, 5, 12
CE2 High to output in low Z	t_{CLZ2}	3	-	3	-	3	-	3	-	3	-	ns	4, 5, 12
$\overline{CE1}$ High to output in high Z	t_{CHZ1}	-	3	-	3	-	3	-	4	-	5	ns	4, 5, 12
CE2 Low to output in high Z	t_{CHZ2}	-	3	-	3	-	3	-	4	-	5	ns	4, 5, 12
\overline{OE} Low to output in low Z	t_{OLZ}	0	-	0	-	0	-	0	-	0	-	ns	4, 5
\overline{OE} High to output in high Z	t_{OHZ}	-	3	-	3	-	3	-	4	-	5	ns	4, 5
Power up time	t_{PU}	0	-	0	-	0	-	0	-	0	-	ns	4, 5, 12
Power down time	t_{PD}	-	8	-	10	-	12	-	15	-	20	ns	4, 5, 12

Read waveform 1 ^{3, 6, 7, 9, 12}

Address controlled

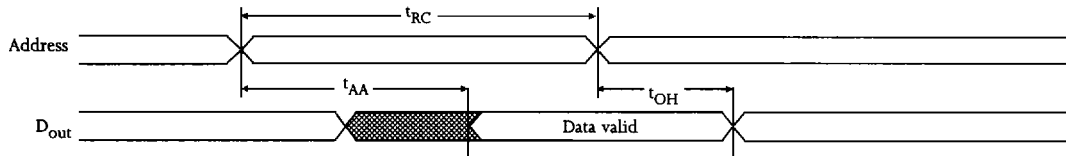

Read waveform 2 ^{3, 6, 8, 9, 12}

$\overline{CE1}$ and CE2 controlled

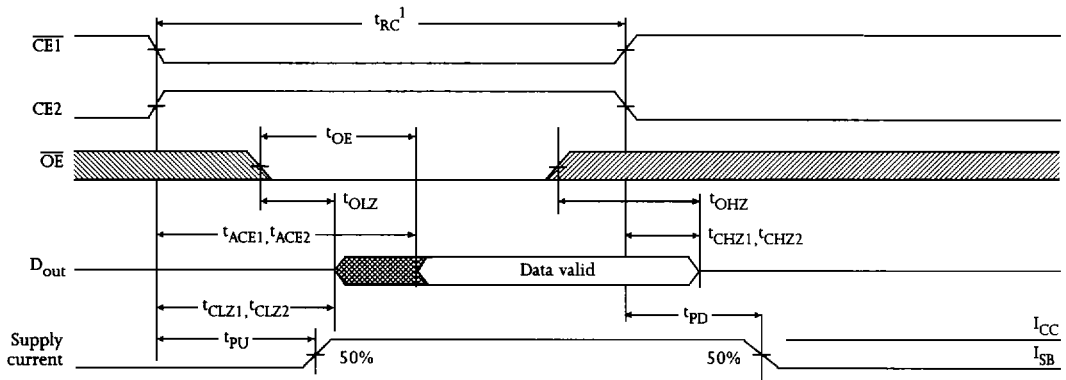



Write cycle

Parameter	Symbol	-8		-10		-12		-15		-20		Unit	Notes
		Min	Max	Min	Max	Min	Max	Min	Max	Min	Max		
Write cycle time	t_{WC}	8	-	10	-	12	-	15	-	20	-	ns	
Chip enable ($\overline{CE1}$) to write end	t_{CW1}	7	-	8	-	9	-	10	-	12	-	ns	12
Chip enable ($CE2$) to write end	t_{CW2}	7	-	8	-	9	-	10	-	12	-	ns	12
Address setup to write end	t_{AW}	7	-	8	-	9	-	10	-	12	-	ns	
Address setup time	t_{AS}	0	-	0	-	0	-	0	-	0	-	ns	12
Write pulse width	t_{WP}	7	-	7	-	8	-	9	-	12	-	ns	
Address hold from write end	t_{AH}	0	-	0	-	0	-	0	-	0	-	ns	
Data valid to write end	t_{DW}	5	-	6	-	6	-	7	-	8	-	ns	
Data hold time	t_{DH}	0	-	0	-	0	-	0	-	0	-	ns	4, 5
Write enable to output in high Z	t_{WZ}	-	5	-	5	-	5	-	5	-	5	ns	4, 5
Output active from write end	t_{OW}	2	-	2	-	3	-	3	-	3	-	ns	4, 5

Write waveform 1^{10, 11, 12}

\overline{WE} controlled

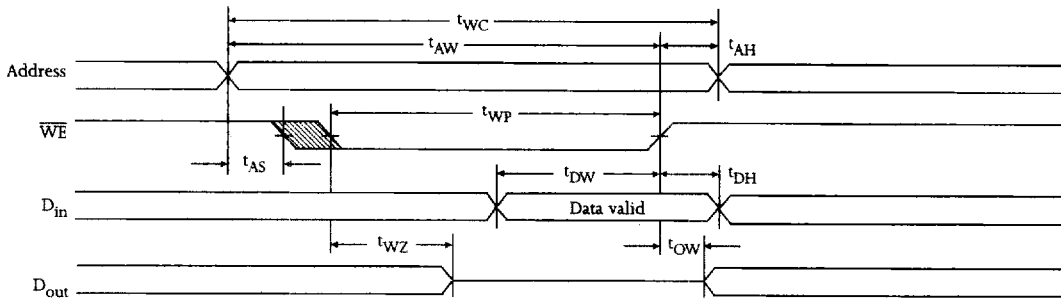

Write waveform 2^{10, 11, 12}

$\overline{CE1}$ and $CE2$ controlled

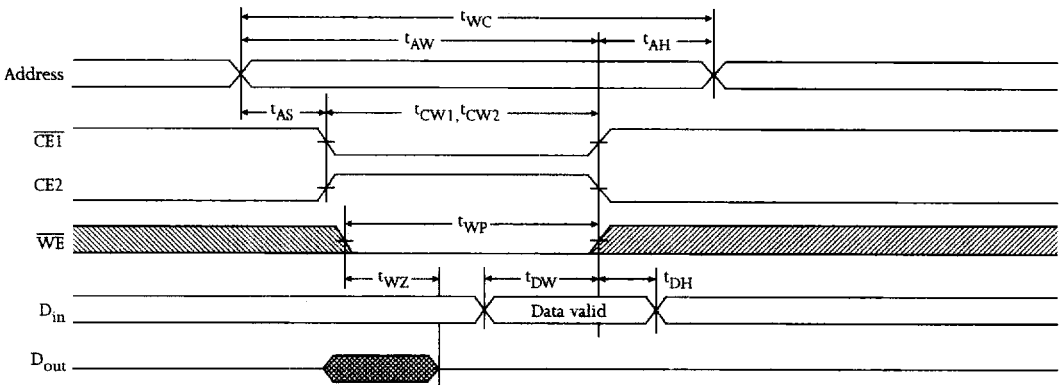



Data retention characteristics

Parameter	Symbol	Test conditions	Min	Max	Unit
V_{CC} for data retention	V_{DR}		2.0	–	V
Data retention current	I_{CCDR}	$V_{CC} = 2.0V$	–	60	μA
Chip enable to data retention time	t_{CDR}	$CE1 \geq V_{CC} - 0.2V$ or $CE2 \leq 0.2V$	0	–	ns
Operation recovery time	t_R		t_{RC}	–	ns

Data retention waveform

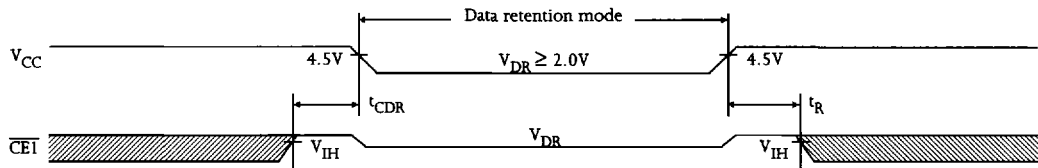

AC test conditions

- Output load: see Figure B, except for t_{CLZ} and t_{CHZ} see Figure C.
- Input pulse level: GND to 3.0V. See Figure A.
- Input rise and fall times: 5 ns. See Figure A.
- Input and output timing reference levels: 1.5V.

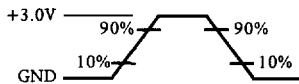

Figure A: Input waveform

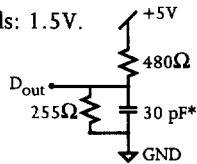
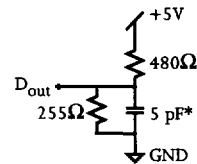

Figure B: Output load

Thevenin equivalent:
 $D_{out} \leftarrow \begin{matrix} 168\Omega \\ +1.728V \end{matrix}$

Figure C: Output load for t_{CLZ} , t_{CHZ}

*including scope and jig capacitance

Notes

- 1 During V_{CC} power-up, a pull-up resistor to V_{CC} on $\overline{CE1}$ is required to meet I_{SB} specification.
- 2 This parameter is sampled and not 100% tested.
- 3 For test conditions, see AC Test Conditions, Figures A, B, C.
- 4 t_{CLZ} and t_{CHZ} are specified with $CL = 5pF$ as in Figure C. Transition is measured $\pm 500mV$ from steady-state voltage.
- 5 This parameter is guaranteed but not tested.
- 6 \overline{WE} is High for read cycle.
- 7 $\overline{CE1}$ and \overline{OE} are Low and $CE2$ is High for read cycle.
- 8 Address valid prior to or coincident with $\overline{CE1}$ transition Low and $CE2$ transition High.
- 9 All read cycle timings are referenced from the last valid address to the first transitioning address.
- 10 $\overline{CE1}$ or \overline{WE} must be High or $CE2$ Low during address transitions.
- 11 All write cycle timings are referenced from the last valid address to the first transitioning address.
- 12 $\overline{CE1}$ and $CE2$ have identical timing.



Typical DC and AC characteristics

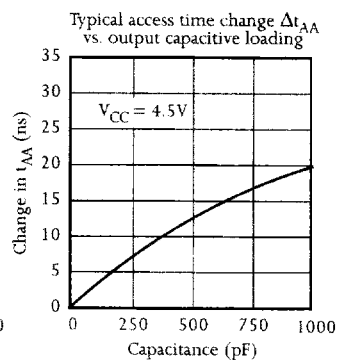
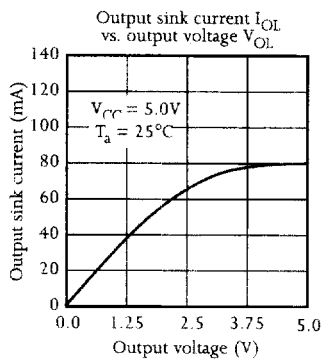
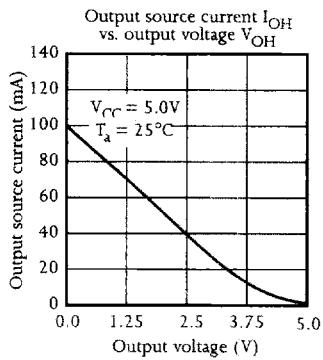
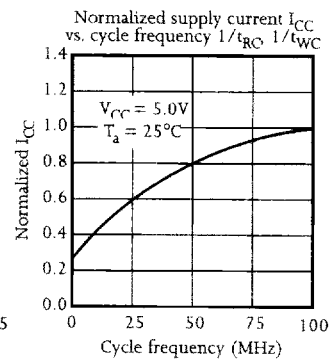
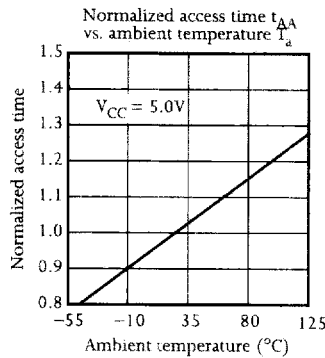
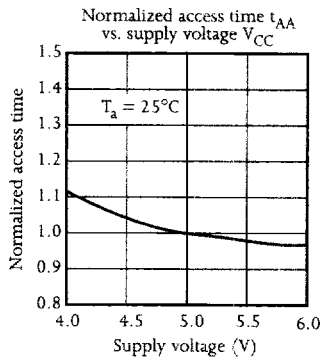
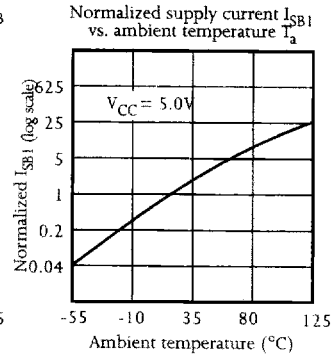
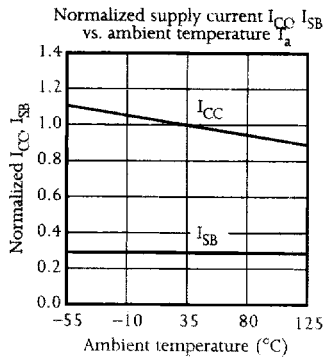
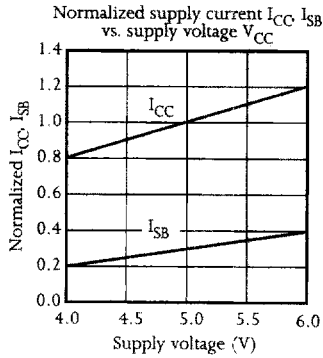

AS7C164



AS7C164 ordering codes

Package \ Access time	8 ns	10 ns	12 ns	15 ns	20 ns
Plastic DIP, 300 mil	-	AS7C164-10PC	AS7C164-12PC	AS7C164-15PC	AS7C164-20PC
Plastic SOJ, 300 mil	AS7C164-8JC	AS7C164-10JC	AS7C164-12JC	AS7C164-15JC	AS7C164-20JC

AS7C164 part numbering system

AS7C	164	X	-XX	X	C
SRAM prefix	Device number	Blank = Standard power	Access time	Package code: P = PDIP 300 mil J = SOJ 300 mil	Commercial temperature range, 0°C to 70 °C